

# High Pass Filter 4.0 ~ 18.0GHz

## Application

- ▶ Wireless communication system.
- ▶ Audio processing, image and data acquisition.
- ▶ Biomedical signal processing.
- ▶ Radar and sensors.
- ▶ It supports a one-year standard warranty.

## RF Characteristics

Part Number	Frequency Range (GHz)	Insertion Loss Max(dB)	VSWR Max	Rejection	Connector Type
5o2830250418SK	4.0 ~ 18.0	1.5	2	60dB @DC-2.7GHz	SMA Female

## Basic Specifications

Dimension	30*25*11mm	Impedance	50Ω
Power	30W	Operating Temperature	-40~+85°C
Appearance color	Black	Storage Temperature	-55~+125°C

## Overall Dimension(mm)

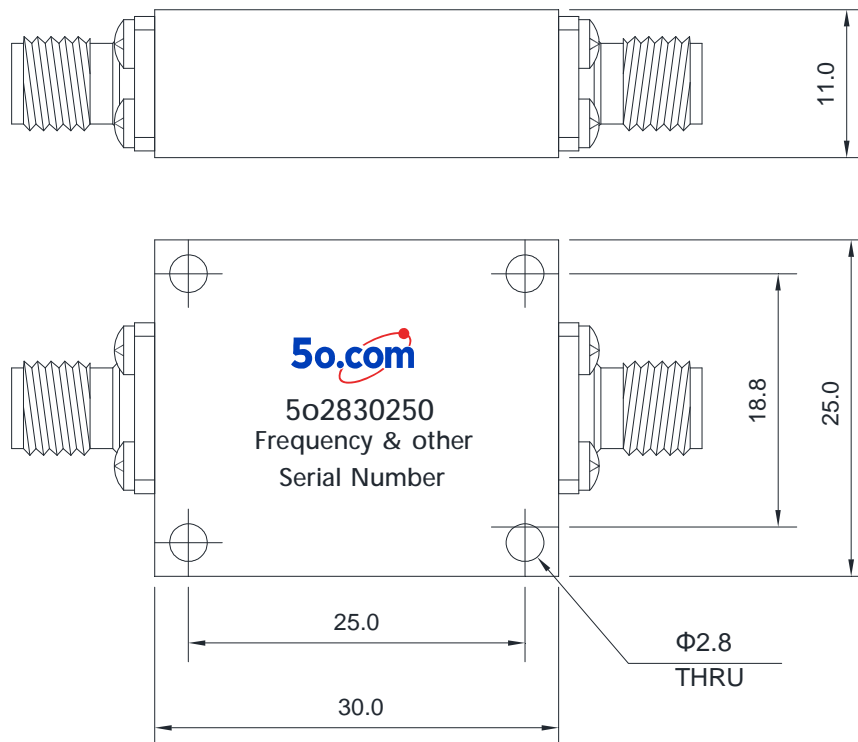

Tolerances: ±2% unless otherwise stated.