

200W Coaxial Attenuator DC-8GHz

Application

- ▶ Wireless communication system.
- ▶ Radar and satellite systems.
- ▶ Testing and measuring equipment.
- ▶ Military, Space and Commercial applications.

RF Characteristics

Part Number	Frequency range	Power	Attenuation Value	Attenuation Tolerance	VSWR Max
5o2020008N10	DC-8GHz	200W	10 dB	±0.8 dB	1.25
5o2020008N20			20 dB	±0.8 dB	1.25
5o2020008N30			30 dB	±0.9 dB	1.25
5o2020008N40			40 dB	±0.9 dB	1.25
5o2020008N50			50 dB	±0.9 dB	1.25
5o2020008N60			60 dB	±0.9 dB	1.25

Basic Specifications

Impedance	50Ω	Connector Type	N Male to Female
Power	200W	Storage Temperature	-55~+125°C

Overall Dimension(mm)

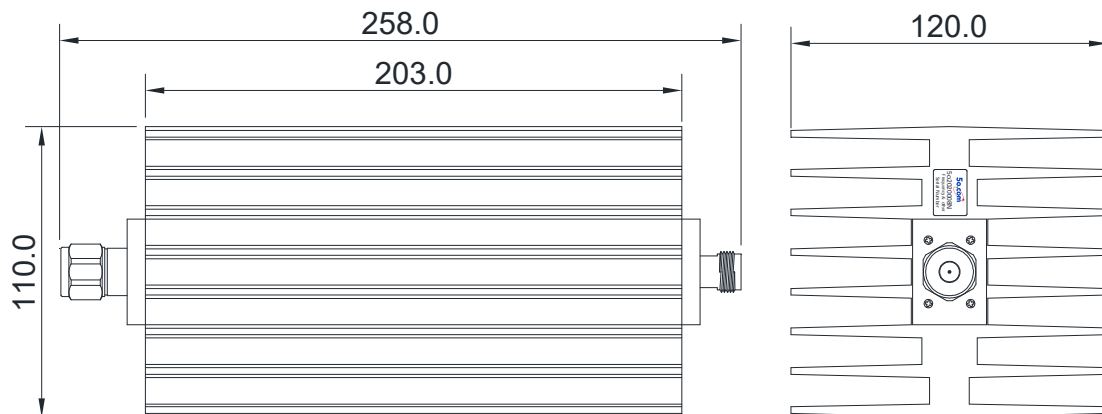

Tolerances: ±2% unless otherwise stated.

Power Derating Diagram

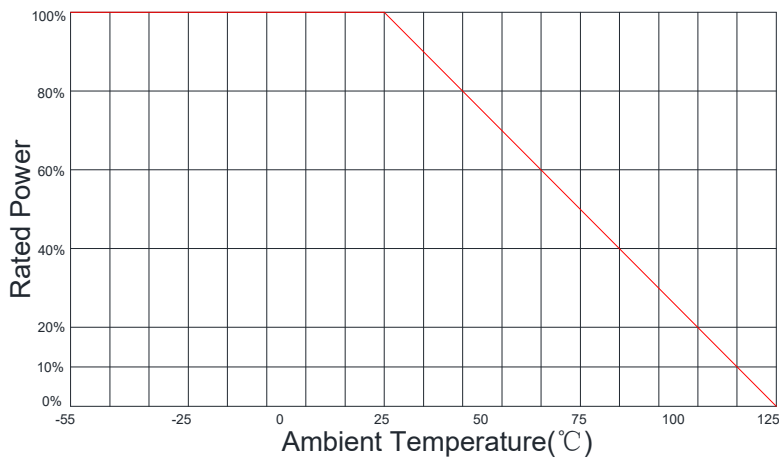

Notes

- ◆ Coaxial attenuator impedance matched to 50Ω.
- ◆ If necessary, the product shall be air-cooled for auxiliary heat dissipation.
- ◆ For products with a power of over 50W, pay attention to the direction during use and strictly avoid reverse connection.
- ◆ Custom design is available upon request.
- ◆ It supports a one-year standard warranty.