

# Drop in Circulator 1.7~ 3.5GHz

## Application

- ▶ RF power amplifier protection.
- ▶ Digital, Satellite, Mobile Communication.
- ▶ Medical, Communication, Security.
- ▶ Military, Space and Commercial applications.

## RF Characteristics

Part Number	Frequency Range (GHz)	Isolation Min(dB)	VSWR Max	Insertion Loss Max(dB)	Connector Type
5o11404001735	1.7 ~ 3.5	17	1.4	0.7	TAB

## Basic Specifications

Dimension	40*40*20mm	Impedance	50Ω
Forward Power	100W	Operating Temperature	0 ~ +70°C
Reverse Power	100W	Storage Temperature	-55~+125°C

## Overall Dimension(mm)

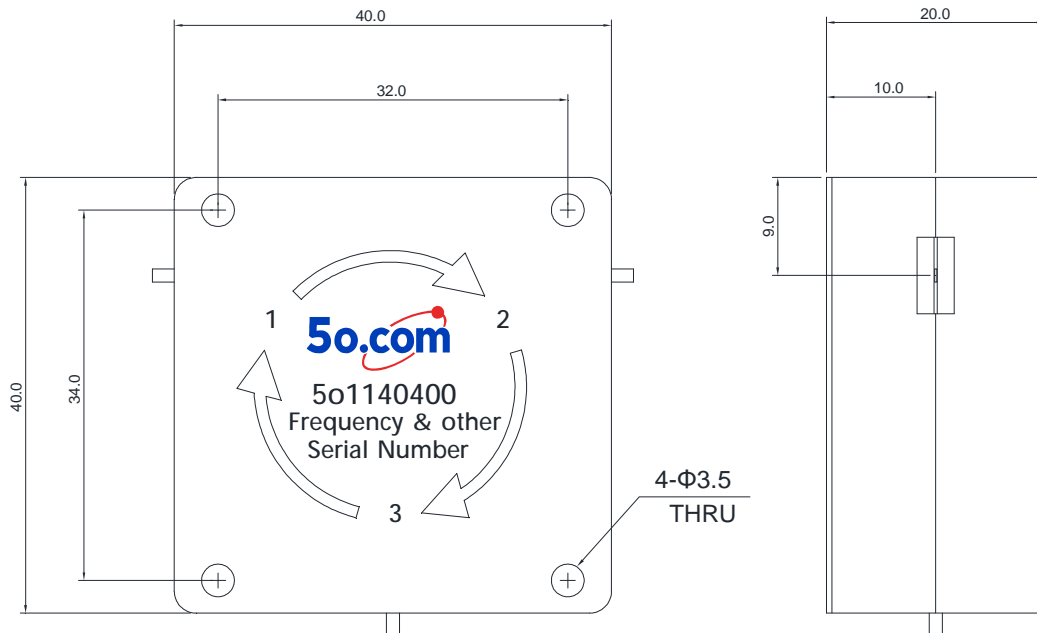

## Instructions

Tolerances: ±2% unless otherwise stated.

- ◆ It can be dual junction or multiple for high isolation.
- ◆ Installing the embedded isolator/circulator, please use stainless steel or brass screws.
- ◆ Only some common frequencies in the table can be produced according to the user's requirements.
- ◆ It supports a one-year standard warranty.