

Waveguide Isolator 8.0 ~ 12.0GHz

Application

- ▶ RF power amplifier protection.
- ▶ Digital, Satellite, Mobile Communication.
- ▶ Medical, Communication, Security.
- ▶ Military, Space and Commercial applications.

RF Characteristics

Part Number	Frequency Range (GHz)	Isolation Min(dB)	VSWR Max	Insertion Loss Max(dB)	Connector Type
5o0648930812	8.0 ~ 12.0	18	1.3	0.5	WR90(BJ100)

Basic Specifications

Dimension	48*93*42mm	Impedance	50Ω
Forward Power	100W	Operating Temperature	-40 ~ +85°C
Reverse Power	30W	Storage Temperature	-55~+125°C

Overall Dimension(mm)

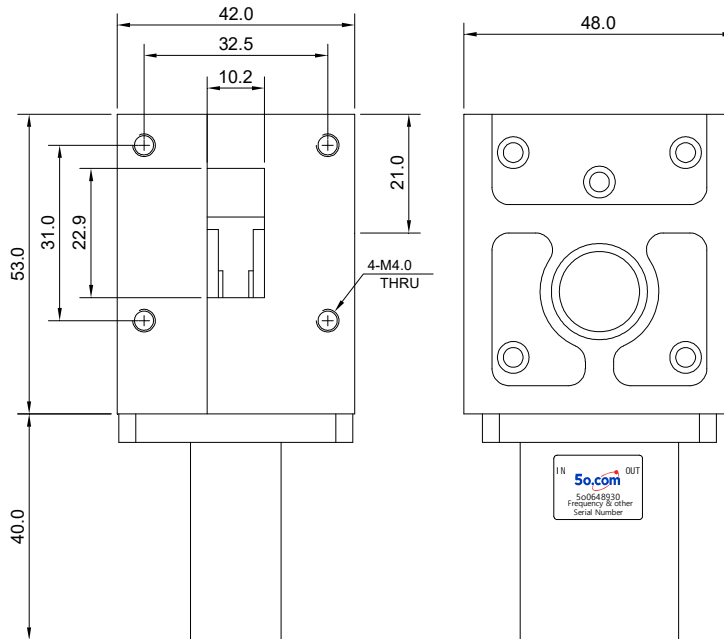

Instructions

Tolerances: ±2% unless otherwise stated.

- ◆ The waveguide isolator shall be accurately mated with the matching waveguide flange.
- ◆ During installation, ensure the flange surface is clean and free of impurities (e.g., metal debris, dust). The flange connecting bolts shall be tightened evenly to prevent radio frequency (RF) leakage and excessive voltage standing wave ratio (VSWR) caused by poor sealing or uneven stress.
- ◆ Only some common frequencies in the table can be produced according to the user's requirements.
- ◆ It supports a one-year standard warranty.